

AMERICAN EAGLE

DRAWER SYSTEMS



AMERICAN EAGLE

American Eagle drawer sets are engineered to withstand extreme levels of use and abuse!

- Certified* 500 lb. rated heavy-duty slides for durability and effortless operation.
- Standard and custom sizes and configurations available.
- All steel construction for superior strength and long life.
- Drawer fronts are powder-coated gray for a great looking, long lasting finish.
- All unpainted components are galvanized for rust free durability (and no chipped paint like many competitive units).
- Single T-shaped handle for convenient one-handed operation.
- Easy installation.
- Designed and manufactured by American Eagle, an employee owned company located in Garner, Iowa.
- Lifetime warranty on slides and hardware.

**Certified by SGS, a leading inspection, verification, and certification company.*

DRAWER SYSTEMS



*Designed & Manufactured
in the USA*



WHY AMERICAN EAGLE SHOULD BE YOUR

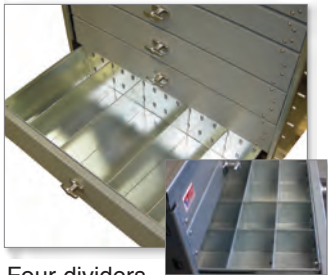

Four dividers are included in each drawer for tool organization. *(Egg crate dividers are also available for small parts storage).*

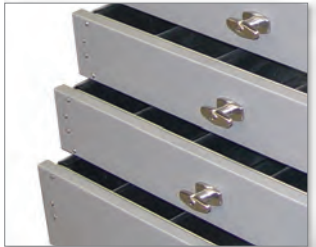

Galvanized components with powder coated drawer fronts for a great appearance and long lasting durability.

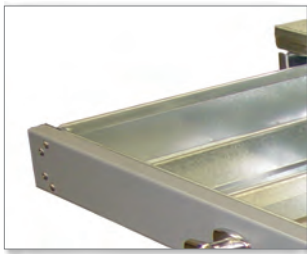

Drawer edges are hemmed for added strength.

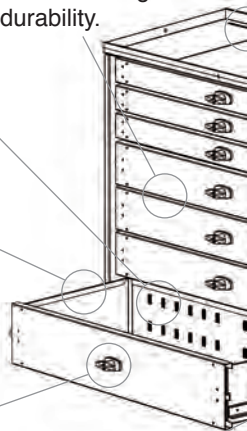

Single handed T-shaped latch for convenient one-handed access. All drawers are keyed for security.

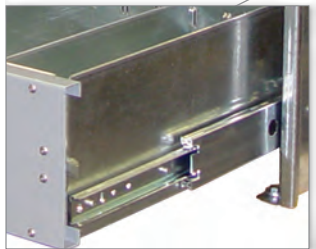

Certified* heavy-duty 500 lb. drawer slides for superior strength.

ANGLE CHOICE



Telescoping top shelf for easy installation. A space-saving flattop is also available.



Removable drawers for:

1. Ease of installation.
2. Move tools closer to your work.
3. Quick retrieval of lost or jammed tools.

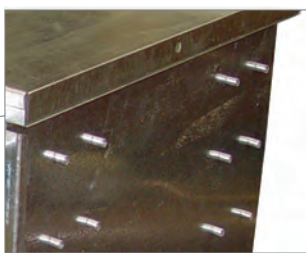
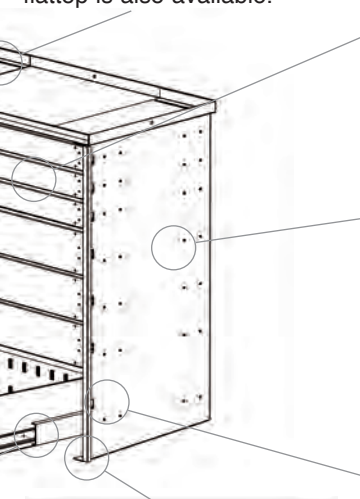

Heavy-duty 14-gauge steel sides for durability.



Standard 2.50" riser built-in with slotted mounting holes for quick installation. *(No riser or special riser kits available).*



Concealed latching hardware and latch-guard for durability and security.

AMERICAN EAGLE

Shop Tool Box

Need a drawer system for your shop?

A heavy-duty enclosure is available for all drawer systems, which includes:

- Heavy 10-gauge powder-coated gray steel top for long life and to use as a work surface or shelf.
- Heavy-duty galvanized steel side and back panels for a strong attractive finish.
- Four heavy-duty (700 lb.) casters for easy rolling and durability.



DRAWER SYSTEMS

Bolt Bins

American Eagle bolt bin units are an excellent storage system for nuts, bolts, fittings, and more!

- Constructed of heavy 16-gauge steel – more than twice the thickness of similar competitive units to withstand rough use.
- Entire units, inside and out, are painted with chip-resistant powder paint for an attractive appearance and superior durability.
- Built-in pull style handle for easy access.
- Base angles downward so bins remain in, except when accessed.
- Spot-welded for durability and simple bolt-down construction for rigidity and quick installation - ready-to-use right out of the box.
- Each bin includes 3 removable aluminum dividers (7 slots per drawer) so each bin can be custom configured.
- Many standard configurations to choose from, and custom units are available to fit your needs.
- Bins measure 4-1/8" H x 6-3/4" W x 17-1/4" D for plenty of storage room.



***Design the drawer set how you want it...
and we'll make it!***

What we can do for you:

- 12" – 50" wide (in even inch increments)
- 10" – 60" deep (in even inch increments)
- Drawer heights of 3", 5" and 7"
- Standard 2.5" riser height

Options:

- No riser and special riser kits
- Space saving flat top
- Egg crate dividers
- Full enclosures with casters
- Hinged work top trays
- Special hanging configurations
- Quick design and manufacturing lead-time

Other ideas? Call us! We are here to make your job easier!

A drawer set measurement guide is available on the website: **www.americaneagleacc.com**



*What work trucks
are built around.*

740 N. State Street

P.O. Box 169

Garner, IA 50438

Telephone: (641) 923-2425 • (800) 392-3015

Fax: (641) 923-9099

Internet: www.americaneagleacc.com

Email: sales@americaneagleacc.com

Specifications may change without notification.

Copyright © 2013 American Eagle Accessories Group

The American Eagle logo is registered in the U.S. Patent and Trademark Office.